

# **InsightPower UPS SNMP Card**

**User's Manual**

# Table of Contents

<b>Chapter 1 Introduction</b>	<b>3</b>
Model Differences	3
Features	3
System Application	4
<b>Chapter 2 First Installation</b>	<b>5</b>
Trouble Shooting	5
<b>Chapter 3 Configuration</b>	<b>8</b>
Configuring the InsightPower by EzSetting	8
Configuring the InsightPower through COM Port	9
Configuring the InsightPower through Telnet	10
Text Mode Configuration	10
User Manager	10
System Configuration	11
SNMPv1 Access Control	13
SNMP Trap	13
Time Server	14
Wake On LAN	14
Upgrade Firmware	14
Soft Restart	15
Reset All To Default	15
Exit Without Save	15
Save And Exit	15
<b>Chapter 4 Managing InsightPower</b>	<b>16</b>
Running the Web Browser (Internet Explorer)	16
Smart Shutdown	16
UPS Shutdown Schedule	16
UPS Shutdown during Power Crisis	17
Wake Computer Up	17
Email Notification	17
SNMP Access Control Setting	17
Power Fail/Restore Simulation	18
Updating UPS SNMP Device Firmware from Windows	18
<b>Chapter 5 Shutdown Software</b>	<b>19</b>
Installation of InsightPower Client in Windows	19
Installation of SNMP Shutdown Agent in Windows	19
<b>Chapter 6 Specification</b>	<b>20</b>
Technical Specification	20
PIN Assignment	20
DIP Switch Definition	20
LED Indicator	20

# Chapter 1 Introduction

## Model Differences

There are 2 models for SNMP card: One is InsightPower SNMP card with golden finger connector, the other one is mini SNMP card. Their outlines are as the following:

- **InsightPower SNMP Card**



There is an additional COM port for InsightPower SNMP card with golden finger. This COM port is used to do the configuration or connect to a environmental sensor box.

- **mini SNMP Card**

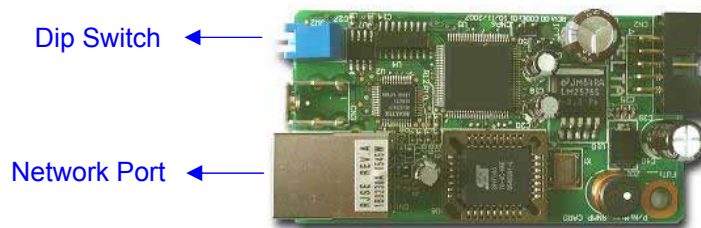

Due to the limitation of PC board size, mini SNMP card has no COM port; other than that, the other features are all the same.

**The settings of Dip Switch are different, too. In the normal mode, InsightPower SNMP card needs to set the dip switches to the OFF position but the mini SNMP card needs to set to the ON position.**

## Features

- **Network connection through RJ45 connector**  
Allows connection of the UPS directly to the ethernet network through a RJ45 connector without using RS232 ports on the computer and without loading any individual UPS management software on the network server.
- **Network UPS management**  
Allows remote management of the UPS from any workstation through Internet or Intranet.
- **Remote UPS monitoring via SNMP, HTTP**  
Allows monitoring of the UPS using Delta MIB (Management Information Base), Internet Browser.
- **Configure UPS and system functions from any client (password protected)**

## InsightPower

Set UPS and system parameters from any SNMP management station or through Internet Browsers using HTTP forms and objects.

- **Keep event logs & metering data in EEPROM**  
Provides a history data of UPS power events, power quality, UPS status and battery condition.
- **Multiple server shutdown**  
The shutdown software included provides automatic shutdown either pre-programmed by administrator or when critical power events.

... also

- **Notification of users via SNMP Traps and e-mail through SMTP**
- **Network Time Protocol supported**
- **Telnet support for configuration**
- **BOOTP/DHCP supported**
- **NetBIOS Name Service supported**
- **MD5 HTTP security**

## System Application

InsightPower is an interface between UPS and the network. It can obtain the status from a UPS and issue commands to it. InsightPower supports two kinds of protocol – SNMP and HTTP for user access. Through the SNMP NMS and Web Browser, user can obtain the UPS status, issue commands to UPS and setting up InsightPower through the network.

InsightPower also provides shutdown software for various OS. The shutdown software that runs under various OS can link to InsightPower automatically through the network and communicate with InsightPower via SNMP protocol. The shutdown software retrieves UPS information from InsightPower. Shutdown software will then proceed to the shutdown process in order to prevent the abnormal shutoff of host or server due to power events.

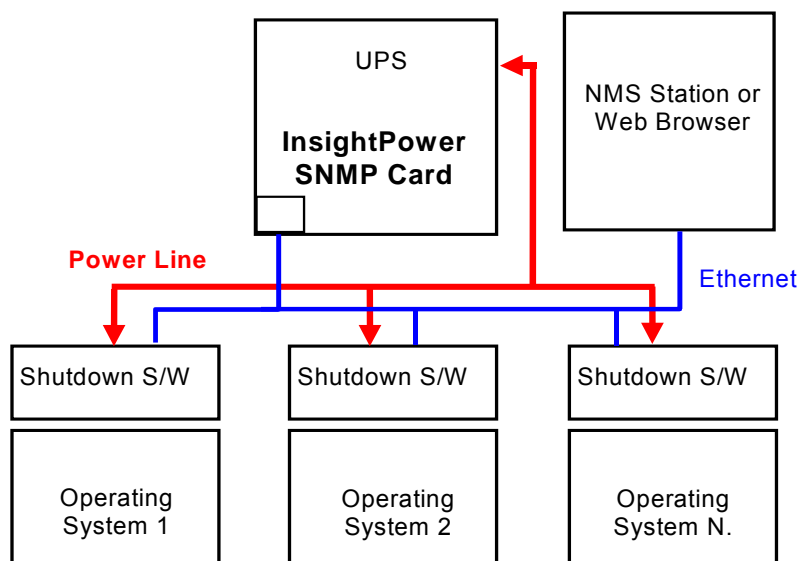

Figure 1-1 System Application Diagram

## Chapter 2 First Installation

Please check your network environment, if there is a **BOOTP/DHCP** server in your LAN then begin from step 1, otherwise start from step 9.

1. Connect the InsightPower device in your LAN.
2. Open the internet browser and link to the InsightPower device by typing the default host name "**InsightPower**" in the address edit box.
3. Login as administrator with "**admin**" account and "**password**" for default password.
4. Open the "User Manager" page to manage your accounts and passwords.
5. There is a limitation in the "**User Manager**" page to restrict the login users to login in the same LAN or not. Select "**Only in This LAN**" option to restrict this login account can only login in the same LAN with the SNMP card, selecting "**Allow Any**" allows this account to login from anywhere.
6. Switch to the "**System Configuration**" page and change the default Host Name.
7. Configure the IP address, Subnet Mask, Gateway IP for InsightPower device. If there is no DNS server then you need to assign IP address for mail server if you want to be notified e-mail.
8. We recommend you to disable the BOOTP/DHCP option and assign a valid static IP address.
9. Open the "**Time Server**" page to synchronize the InsightPower device and time server. Please refer to next section on how to construct your SNTP server.

If you have no BOOTP/DHCP server in your LAN then follow belows:

10. Make sure both of the InsightPower device and your workstation are in the same LAN.
11. Open EzSetting from CD, and refer to next chapter for configuring InsightPower by **EzSetting**.
12. You need to change the Host Name, IP Address,...
13. Because there is no BOOTP/DHCP server in your network environment, you need to disable BOOTP/DHCP option in the System Configuration group.
14. Please refer to next Chapter "Configuring the InsightPower by EzSetting" section for more detail information on configuring the InsightPower in an easy way.

## Trouble Shooting

### 1. How to provide a SNTP(Simple Network Timer Protocol) server for InsightPower?

Answer: There are 2 ways to provide a network time server for InsightPower:

The easiest way is to install the InsightPower Client software, you can find it in the bundled CD.

The other one is to install the "Simple TCP/IP Services" of "Networking Services" from "Add/Remove Windows Components". You may need a Windows CD while installing.

Don't forget to provide the IP address of the host in the Time Server page.

### 2. How to make sure the network connection is established between my workstation and InsightPower?

Answer: Check the networking connection by typing the following command "ping *HostName or IP*" from your workstation.

### 3. In the internet explorer, I can see the “Login” page but cannot login?

Answer: Please check the IP addresses of the SNMP card and the PC which you try to login. If both of the IP addresses are not in the same LAN then please run the EzSetting utility to configure the User Limitation to Allow Any.

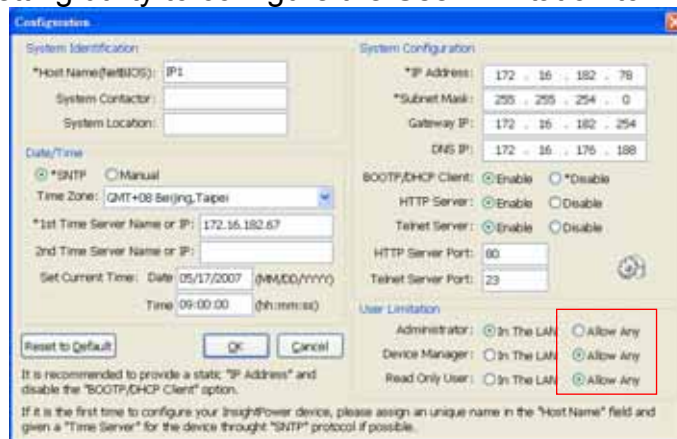

### 4. How to refresh the NetBIOS table in Windows operating system?

Answer: Sometimes the IP address of InsightPower will be changed but keep the same host name, although Windows will update its NetBIOS table periodically but we can force it to purge its cache immediately by typing the following command “nbtstat -R. After that you can connect to the InsightPower by its host name.

### 5. How to get the IP address and MAC address from my computer?

Answer: In Windows system, please type “ipconfig /all” in DOS prompt. For Unix system please use “ifconfig” in the shell.

### 6. Unable to ping or connect to the adapter.

Answer:

1. Check all network connections.
2. Ensure that your PC and the InsightPower are on the same network segment. (If you don't have a router, this must be true.)
3. It may be that your "arp table" contains invalid entries. You can clear the "arp table" by rebooting, or by typing the following command at the command prompt or *Run* dialog box.: `arp -d`
4. You can connect to the InsightPower ONLY if your PC and the InsightPower are using IP Addresses from the same address block. Normally, private LANs use IP Addresses from ONE of the following blocks, which are reserved for this purpose:  
10.0.0.0 ~ 10.255.255.255  
172.16.0.0 ~ 172.31.255.255  
192.168.0.0 ~ 192.168.255.255

The InsightPower's default IP address (192.168.1.100) is from the last block. If your LAN is using a different address block, then you will NOT be able to connect to the UPS Adapter via the LAN.

In this case, your choices are:

- Use Terminal Mode configuration to set the InsightPower's IP Address.
- Use the TCP/IP *arp* utility to provide a (temporary) IP Address to the InsightPower.
- Change your PC's IP Address to allow connection via the LAN.

**7. Unable to perform SNMP get operations.**

Answer: Check the SNMP settings stored in the InsightPower. The IP Address of the PC you are using must be entered in one of the SNMP Access Control NMS IP fields, with Read or Read/Write permission. The Community String on the PC and InsightPower must match.

**8. Unable to perform SNMP set operations.**

Answer: Check the SNMP settings stored in the InsightPower. The IP Address of the PC you are using must be entered in one of the SNMP Access Control NMS IP fields, with Read/Write permission. The Community String on the PC and UPS Adapter must match.

**9. Unable to receive traps at your management station.**

Answer: Check the SNMP Trap settings in the InsightPower. The IP Address of the PC you are using must be entered in one of the Target IP fields. The Community String on the PC and InsightPower must match.

**10. Forget the administrator's account and password.**

Answer: Connect the configuration cable in console port and set both of the DIP-switches of InsightPower to ON position (configuration mode) and key in the "radmin" while the account and password are prompted in 30 seconds. Now the account and password of administrator are reset to default values.

## Chapter 3 Configuration

The easiest way to configure the InsightPower is running EzSetting, you can find the software in the CD. Please see below sub-section for more information.

If you have configured the essential network parameters successfully, you can launch the internet browser or telnet to the device which you just assigned to do detail configuration. The first thing is to open the User Manager page and change your accounts and passwords.

### Configuring the InsightPower by EzSetting

1. Prepare a workstation (Microsoft Windows 9x, Me, NT4.0, 2000, 2003, XP or later installed).
2. Make sure both the DIP-switches of InsightPower to OFF position (default: normal mode) to enable network transmission.
3. Make sure the workstation and InsightPower device are in the same LAN.
4. Put the provided CD in the CD-ROM drive and find the InsightPower EzSetting then launch it.
5. Press the Discover button to search all of the UPS in the LAN. All of the UPS SNMP DEVICE will be listed in the Device List. (See 2-1)

If you want to search the InsightPower devices in a different domain network, just change the subnet and subnet mask addresses then press the Discover button to list them.

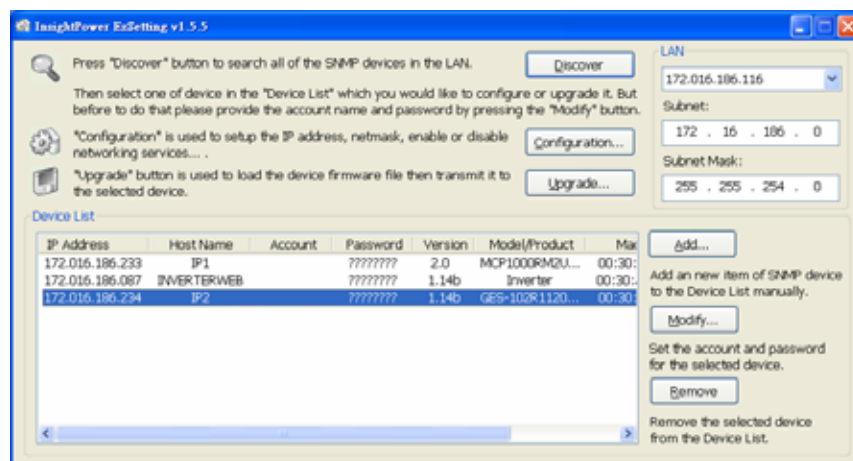

Figure 2-1 EzSetting screen.

6. If the InsightPower device can not be found, check the networking port UDP 3456 in the OS. Open it if it is blocked.
7. Select the device in the device list to configure the network parameters then press the Modify button to provide your account and password. The default account and password are **admin** and **password**. (See 2-2)



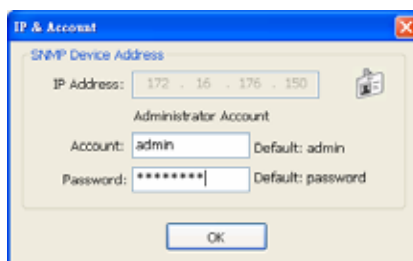

Figure 2-2 Provide the account and password.

- Click on the Configuration button and setup the essential network parameters. (See 2-3)

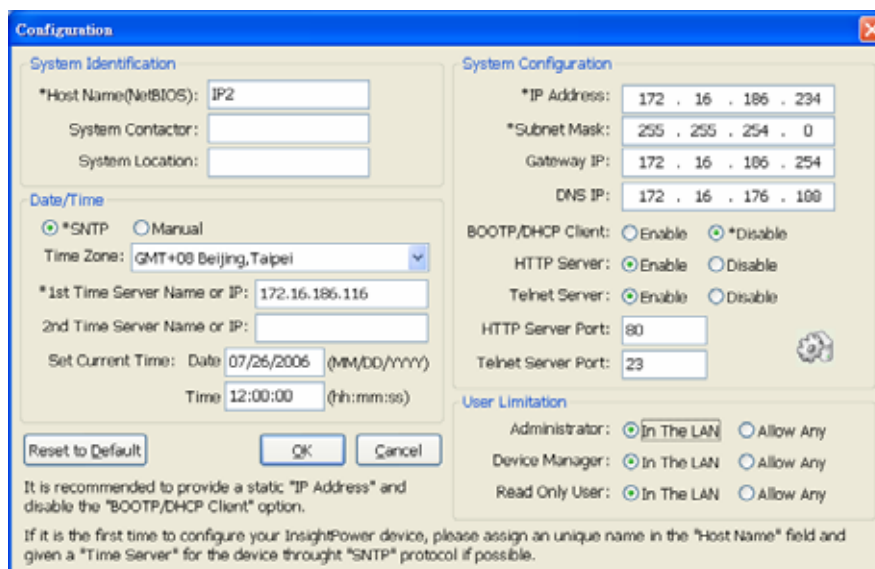

Figure 2-3 Configure the system parameters.

## Configuring the InsightPower through COM Port

- Prepare a workstation (Microsoft Windows 9x, Me, NT4.0, 2000, 2003, XP or later installed).
- Use the RJ45 to DB9 serial cable that provided from package connect between the InsightPower COM port and the COM port on the workstation.
- Set both the DIP-switches of the InsightPower device to OFF position (normal mode).
- From the workstation running Microsoft Windows (9x, Me, NT4.0, 2000, 2003, XP or later), and click on the *HyperTerminal* icon of the accessory programs group.
- Enter a name and choose an icon for the connection.
- Select direct COM port connection.
- Setup the COM port parameters - 2400 bps, 8 data bits, no parity, 1 stop bit and no flow control.
- Set both the DIP-switches of the InsightPower to **ON** position (configuration mode). Messages will then are displayed on the screen; afterwards, key in the administrator account (default account is **admin**) and password (default password is **password**). The InsightPower configuration utility main menu will be displayed on the screen. Please refer to the Text Mode Configuration section for more information.

## Configuring the InsightPower through Telnet

1. Connect the InsightPower to the network.
2. Prepare a workstation (Microsoft Window, Max OSX or Linux installed) which is connected to the same LAN.
3. Make sure both the DIP-switches of the InsightPower to OFF position (normal mode).
4. From the Windows workstation running DOS Prompt and type “telnet *HostName or IP*” to open the telnet connection with InsightPower. For other operating system user, please run the OS shell and type the same command as in the DOS prompt.
5. Messages will then are displayed on the screen; afterwards, key in the administrator account (default account is **admin**) and password (default password is **password**). The InsightPower configuration main menu will be displayed on the screen. Please refer to the Text Mode Configuration section for more information.

**Note:** InsightPower will terminate the telnet connection if there is no data transmission in 1 minute.

## Text Mode Configuration

```
+-----+
| UPS Web Card Main Menu |
+-----+
UPS Web Version 1.0
[1].User Manager
[2].System Configuration
[3].SNMP Access Control
[4].SNMP Trap
[5].Time Server
[6].Mail Server
[7].Wake On LAN
[8].Upgrade Firmware
[9].Soft Restart
[a].Reset All To Default
[b].Reset Hub To Default
[z].Exit Without Save
[0].Save And Exit

Please Enter Your Choice =>1
```

Figure 2-4 InsightPower Main menu.

## User Manager

```
+-----+
|   User Manager   |
+-----+
Administrator
[1].Account:  admin
[2].Password:  *****
[3].Limitation: Only in This LAN
Device Manager
[4].Account:  device
[5].Password:  *****
[6].Limitation: Only in This LAN
Read Only User
[7].Account:  user
```

```

[8].Password:  *****
[9].Limitation: Only in This LAN
[0].Back To Previous Menu

Please Enter Your Choice =>
    
```

**Figure 2-5 InsightPower User Manager menu.**

No.	Function	Description	Default
1.	Administrator Account	Administrator gets the whole rights to modify the InsightPower and UPS settings.	"admin"
2.	Administrator Password		"password"
3.	Administrator Limitation	Restrict login area of the administrator user	Only in This LAN
4.	Device Account	Device Manager is permitted to change the network setting but has the ability to configure the UPS settings.	"device"
5.	Device Password		"password"
6.	Device Limitation	Restrict login area of the device manager	Only in This LAN
7.	User Account	Read Only User can observe the UPS information only.	"user"
8.	User Password		"password"
9.	User Limitation	Restrict login area of the general user	Only in This LAN

## System Configuration

```

+=====+
| System Configuration |
+=====+
[1].IP Address:          192.168.001.100
[2].Subnet Mask:        255.255.255.000
[3].Gateway IP:         192.168.001.254
[4].DNS IP:             192.168.001.001
[5].BOOTP/DHCP Client:  Enable
[6].HTTP Server:        Enable
[7].Telnet Server:      Enable
[8].FTP Server:          Enable
[9].HTTP Server Port:    80
[a].Telnet Server Port:  23
[b].SNMP Get,Set Port:   161
[c].SNMP Trap Port:     162
[d].Host Name(NetBIOS):  INSIGHTPOWER
[e].System Contactor:
[f].System Location:
[g].Status Stable:      3
[0].Back To Previous Menu

Please Enter Your Choice =>
    
```

**Figure 2-6 System Configuration Menu.**

No.	Function	Description	Default
1.	IP Address	The InsightPower IP address.	192.168.001.100
2.	Subnet Mask	The sub-net mask setting.	255.255.255.000
3.	Gateway IP	The network default gateway.	192.168.001.254
4.	DNS IP	Domain Name Server IP address	192.168.001.001
5.	BOOTP/DHCP Client	Enable/Disable BOOTP/DHCP protocol	Enable
6.	HTTP Server	Enable/Disable HTTP protocol	Enable
7.	Telnet Server	Enable/Disable telnet protocol	Enable
8.	FTP Server	Enable/Disable FTP protocol For batch configuration purpose	Enable
9.	HTTP Server Port	HTTP networking port	80
a.	Telnet Server Port	Telnet networking port	23

## InsightPower

b.	SNMP Get,Set Port	SNMP polling and response port	161
c.	SNMP Trap Port	SNMP trap port	162
d.	Host Name(NetBIOS)	Host name for Windows	INSIGHTPOWER
e.	System Contactor	Alphanumeric string	
f.	System Location	Alphanumeric string	
g.	Status Stable	Status change confirmation check time	3

## SNMPv1 Access Control

If you wish to use a workstation with SNMP Manager installed, or if you wish to set more restrictive InsightPower access, you can use the access table to add the IP address of the PC's on which you wish to modify the access permissions. (Figure 2-7)

The communication protocol between shutdown software (InsightPower Client) and the InsightPower device is SNMP, the administrator needs to maintain this table for all workstations to keep UPS and workstations work correctly.

The index 01 is a special design for all read only workstations. InsightPower checks community string first to identify the incoming packet is read only or not. If they are identical then InsightPower responses the inquiring value.

```

+=====+
|      SNMP Access Table      |
+=====+
Index  NMS IP           Community   Permission
[1]01  Other SNMP NMSs  public     Read Only
[2]02  172.016.176.141  insightpower Read/Write
[3]03  000.000.000.000   Not Access
[4]04  000.000.000.000   Not Access
[5]05  000.000.000.000   Not Access
[6]06  000.000.000.000   Not Access
[7]07  000.000.000.000   Not Access
[8]08  000.000.000.000   Not Access
[0].Back To Previous Menn

Please Enter Your Choice =>
    
```

Figure 2-7 SNMP Access Table.

## SNMP Trap

If you want to use a PC and perform the SNMP manager 'trap' function in order to manage UPS through InsightPower, the IP address of the PC must be added to the SNMP Trap list.

The Event Level field is used to decide what kind of power events should be send to the target address. There are 3 levels of power events: Information, Warning and Severity. If you select the Information then all of the power events will be send to the target IP address, warning level will send the Warning and Severity events to the target address.

```

+=====+
|      SNMP Trap      |
+=====+
Index  Target IP           Community   Event Level
[1]    172.016.176.142  insightpower Information
[2]    172.016.176.143  private     Warning
[3]    172.016.176.144  public      Severity
[4]    000.000.000.000   None
[5]    000.000.000.000   None
[6]    000.000.000.000   None
[7]    000.000.000.000   None
[8]    000.000.000.000   None
[0].Back To Previous Menu

Please Enter Your Choice =>
    
```

Figure 2-8 SNMP Trap.

## Time Server

There are 2 ways to provide current time and date to InsightPower, one is set the system time manual but it is not an ideal way. The other one and ideal way is setup a time server for InsightPower, InsightPower supports SNTP which MS Windows XP has been supported.

If you have installed the InsightPower Client from the bundled CD, you can just assign the host in the Time Server IP address. Because InsightPower Client has the ability to act as a time server for InsightPower device.

Instead of that, you need to install the Simple TCP/IP Services from Add/Remove Windows Components.

```
+=====+
|           Time Server           |
+=====+
[1].Time Selection:      SNTP
[2].Time Zone:          -8 hr
[3].1st Time Server:    172.016.176.141
[4].2nd Time Server:    jesse-tri
[5].Manual Date:        01/01/2000 (MM/DD/YYYY)
[6].Manual Time:        00:00:00 (hh:mm:ss)
[0].Back To Previous Menu

Please Enter Your Choice =>
```

Figure 2-9 Time Server.

## Wake On LAN

InsightPower supports the magic packet to wakeup workstations in 2 conditions: power restore or system startup with a delay time.

```
+=====+
|           Wake On LAN           |
+=====+
Index  MAC Address      Delay  Trigger Conditions
[1]    00-0c-08-34-4d-57  001   (Power Restore)(System Startup)
[2]    00-00-00-00-00-00  000
[3]    00-00-00-00-00-00  000
[4]    00-00-00-00-00-00  000
[5]    00-00-00-00-00-00  000
[6]    00-00-00-00-00-00  000
[7]    00-00-00-00-00-00  000
[8]    00-00-00-00-00-00  000
[0].Back To Previous Menu

Please Enter Your Choice =>
```

Figure 2-10 Setting Trap Receivers.

## Upgrade Firmware

InsightPower supports TFTP Client protocol for upgrading new version firmware. You need a TFTP server or just run the EzSetting in the CD to upgrade the firmware.

```
+=====+
|           Upgrade Firmware       |
+=====+
[1].TFTP Server IP: 172.016.176.141
[2].Upgrade Now
[0].Back To Previous Menu
```

Please Enter Your Choice =>

**Figure 2-11 Upgrade Firmware.**

## **Soft Restart**

Simply restart the InsightPower.

## **Reset All To Default**

Clear all of the settings in EEPROM.

## **Exit Without Save**

Exit and disregard the changes.

## **Save And Exit**

Preserve your changes in EEPROM and exit.

## Chapter 4 Managing InsightPower

### Running the Web Browser (Internet Explorer)

1. Make sure that you have a TCP/IP network already installed.
2. If there is no DHCP network service on the network, contact your network administrator to get an IP address for your workstation that has the same network's address as the InsightPower IP address. **The default IP address of InsightPower is 192.168.1.100.**
3. Start your Web Browser. Enter the URL "http://host\_name" or "http://ip\_address" in the address box. The InsightPower will then ask for your account and password, input the correct account and password then UPS management Web home page will be shown on the screen.
4. If the Login web page can be displayed but unable to login with the correct account and password. The reason may be caused by the IP address where you login is different with the SNMP card IP address, please refer to Chapter 2 Trouble Shooting.

**Note:** InsightPower will logout user automatically if there is no data transmission through HTTP connection more than 30 minutes.

### Smart Shutdown

Initiates a signal for the server to shutdown. After the user-defined "Estimated OS Shutdown Delay", the output power is switched off. InsightPower Client or SNMP ShutdownAgent must be used on the server for it to be properly shutdown. The "Estimated OS Shutdown Delay" includes the assigned countdown delay in the shutdown software plus the duration of OS shutdown process.

When shutdown software receives the Smart Shutdown signal, the low battery reaction settings will be used to process the shutdown procedure.

### UPS Shutdown Schedule

#### Only UPS:

InsightPower device supports two kinds of shutdown schedule – (1) Weekly Schedule; (2) Special Day Schedule. Set both of these options to plan your UPS schedule shutdown and restart time.

#### UPS + Shutdown Software(InsightPower Client):

If your InsightPower device needs to work with shutdown software to protect your servers which are powered by the UPS and you want to control the schedule shutdown and restart from InsightPower device then please visit the Configure page and enable the "Perform Smart Shutdown in Schedule" option.

You can also set the schedule at shutdown software side. And because the shutdown software will send the control command to UPS through SNMP to shutdown the UPS, we have to add the server IP address with write permission in the SNMP Table of InsightPower device.

**Note:** Before managing the UPS Shutdown Schedule, please make sure that the Date and Time configured in InsightPower is correct.



## UPS Shutdown during Power Crisis

### Only UPS:

InsightPower responds to 2 different kinds of UPS shutdown events (AC failed, Battery Low). Goes to the Configure in the UPS Management menu. Logging in as an Administrator. Set the options in UPS Shutdown Action section then press the Submit button.

### UPS + Shutdown Software(InsightPower Client):

If your InsightPower device needs to work with shutdown software to protect your servers which are powered by the UPS then you should clear all of the settings of UPS shutdown action in the InsightPower device.

Instead of that, set the reaction shutdown at software side. And because the shutdown software will send the control command to UPS through SNMP to shutdown the UPS, we have to add the server IP address with write permission in the SNMP Table of InsightPower device.

**Note: Once InsightPower detects there is at least one shutdown software running, the event-driven shutdown would be canceled.**

## Wake Computer Up

Please check the BIOS settings and enable WOL option. Then go to the Wake On LAN page in the Network menu. Please note that this feature should only available for the servers in the same LAN with InsightPower device.

## Email Notification

This page describing of UPS email notification setting to let administrator configure Mail server and Mail receivers in order to receive notification or report from InsightPower by email once power event was occurred.

### 1. SMTP Server Name or IP

This item is the Hostname of a SMTP Mail Server that will be used to send email messages from the InsightPower. If entering a Hostname, you are also required to enter the DNS IP in the System Configuration.

### 2. Sender Mail Address

This item is the e-mail sender address in the following format:  
name@company.com.

### 3. Password

This item is the password of Mail Server. Default has no entry, and only required if Mail Server needed for authentication to send mail.

### 4. Receiver

This column is for entering the email address of the individual you wish the InsightPower to send mail to.

### 5. Event Level

This item is for selecting the Severity level of notification you wish to send to each Mail Receiver configured to be sent Mail Type: Events or Events/Status.

## SNMP Access Control Setting

InsightPower supports SNMP protocol. You can use SNMP NMS to manage UPS

through the network. The IP address of the workstation must be entered in the InsightPower write access table to prevent unauthorized users from configuring InsightPower via SNMP protocols.

## Power Fail/Restore Simulation

To make sure the network configuration is correct, InsightPower provides 2 test buttons to simulate power fail and power restore events. After pressing the test buttons, InsightPower send the related SNMP trap to the assigned target hosts and simulate the power event values to SNMP response data.

The power fail simulate will be terminated automatically in 30 minutes to prevent from forgetting press the Power Restore Test button.

## Updating UPS SNMP Device Firmware from Windows

To perform firmware upgrade, use the **EzSetting.exe** program on the CD-ROM. This program is compatible with Windows operating system.

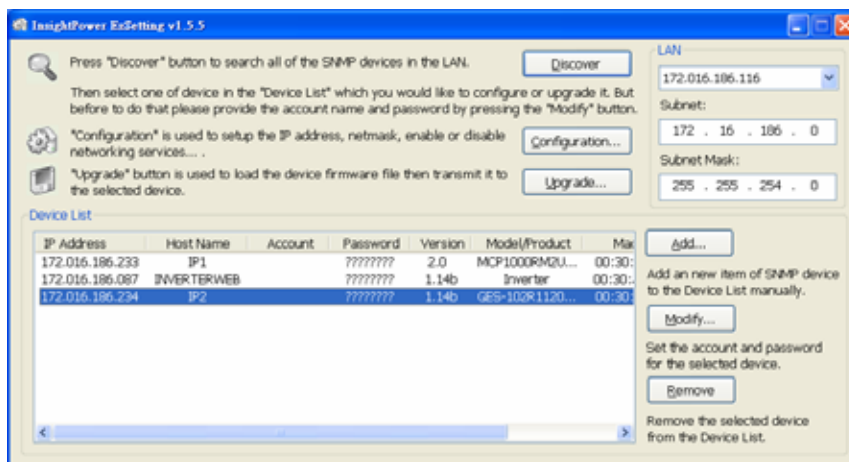

1. **Device List:** Displays the addresses of the UPS SNMP DEVICE present in the local network.
2. **Discover:** Search for the InsightPower devices in the local network.
3. **Add:** Lets you add the IP address of an UPS to the Device List manually.
4. **Modify:** Lets you modify the parameters of the device selected in the Device List.
5. **Remove:** Removes the selected device from the Device List.
6. **Configuration:** Provides an easy way to do the initial configuration through networking UDP port 3456. If you cannot get the device information please check and open the UDP port from your OS.
7. **Upgrade:** Sends the program loaded with the Browse button to the selected device of the Device List.

## Chapter 5 Shutdown Software

There are 2 kinds of shutdown software to help you to protect servers from power crisis. One is InsightPower Client the other one is SNMP ShutdownAgent. Both of them have the ability to shutdown servers gracefully. The major difference is SNMP ShutdownAgent can only receive SNMP traps of power fail and battery low signals but InsightPower Client can observe UPS parameters, record power events and values for you.

### Installation of InsightPower Client in Windows

1. Insert the InsightPower CD-ROM into the CD-ROM drive.
2. Run the "InsightPower Client Setup.exe" program on the CD-ROM.
3. After set-up is complete, please continue to provide the host name or IP address of InsightPower device and community string which has been set in the SNMP Access Control menu. The InsightPower Client service connects to the device automatically when the operating system initiates.

**Please note that when the InsightPower Client connects to InsightPower SNMP Card, the schedule and UPS Shutdown Action settings in the SNMP Card would be ignored until the connection of InsightPower Client is released to prevent from conflicting with the settings in the InsightPower Client software. In this case, you still can configure the schedule shutdown/restart and event-driven shutdown from InsightPower Client software.**

### Installation of SNMP Shutdown Agent in Windows

1. Insert the InsightPower CD-ROM into the CD-ROM drive.
2. Run the "SNMP ShutdownAgent Setup.exe" program on the CD-ROM.
3. After set-up is complete, please continue to provide the IP address of InsightPower device. The SNMP Shutdown Agent open the specific UDP port and listen for SNMP traps when the operating system initiates.

# Chapter 6 Specification

## Technical Specification

Network Connection	RJ-45 jack connector
Operating Temperature	0 ~ 40° C
Operating Humidity	10 ~ 80 %
Power Input	9~24V DC
Power Consumption	1 Watt Maximum
Size	130 mm x 60 mm (L x W)
Weight	58 g

## PIN Assignment

Bottom Side		Component Side	
Pin 1	GND	Pin 2	DC (9-24V)
Pin 3	Txd→UPS	Pin 4	Rxd←UPS
Pin 5	NC	Pin 6	NC
Pin 7	NC	Pin 8	NC
Pin 9	NC	Pin 10	NC
Pin 11~25	NC	Pin 12~26	NC

## DIP Switch Definition

Golden finger SNMP card:

No.	SW1	SW2	Function Mode
1	ON	ON	Console Configuration Mode
2	ON	OFF	For Environmental Sensor
3	OFF	ON	Pass Through Mode
4	OFF	OFF	Normal Mode

Mini SNMP card:

No.	SW1	SW2	Function Mode
1	ON	ON	SNMP Normal Mode, the UPS doesn't response to its RS232 port
2	OFF	OFF	SNMP Stop Mode, PC can communicate with the UPS through its RS232 port

## LED Indicator

No.	Yellow LED	Green LED	Function Mode
1	Flashing(0.2 sec)	ON	Normal operation
2	Flashing(1sec)	ON	UPS Disconnect
3	---	OFF	Hardware or network error